



## Premium Weatherstripping Inc

Dependable Products. Dedicated Experts.

# 2016 ASTRAGAL CATALOG

June 16, 2016 - Rev 0.0

DISCLAIMER: The information contained within this catalog and the functions offered are intended to provide information about products available for purchase from PWS ("Premium Weatherstripping Inc"). All reasonable efforts have been made to ensure the accuracy of the information. However, PWS cannot be held responsible for any errors or unexpected un-fulfillment of shipments. PWS does not warrant the accuracy and reserves the right to make changes to the catalog and its functions at any time without notice. Except where otherwise noted or superseded by process of law, PWS accepts no responsibility or liability for any losses or damages of any kind arising out of the use of this catalog or any of its related functions.

**E:** [sales@pws-group.ca](mailto:sales@pws-group.ca) **T:** (604) 468-6300 **F:** (604) 468-6363 **W:** [www.pws-group.ca](http://www.pws-group.ca)

140 Glacier St., Coquitlam, BC, Canada V3K 5Z6



www.PWS-group.ca

Dependable Products. Dedicated Experts.

# ASTRAGALS

GENERAL INFORMATION	
<b>MATERIAL</b>	ALUMINUM or STEEL
<b>ALUMINUM ALLOY</b>	EXTRUDED 6063-T5
<b>ALUMINUM FINISH</b>	VARIOUS OPTIONS (SEE INDIVIDUAL PRODUCT FOR DETAILS)
<b>INSERTS</b>	VARIOUS OPTIONS, Some REPLACABLE (SEE INDIVIDUAL PRODUCT FOR DETAILS)
<b>STEEL FINISH</b>	PRIMED
<b>STEEL ASTRAGAL STYLE</b>	OVERLAPPING, FACE MOUNT
<b>RATINGS</b>	INDICATED NEXT TO DIAGRAM (QAI20, QAI90)
<b>WARRANTY</b>	1 YEAR

## ALUMINUM

### PILE INSERT

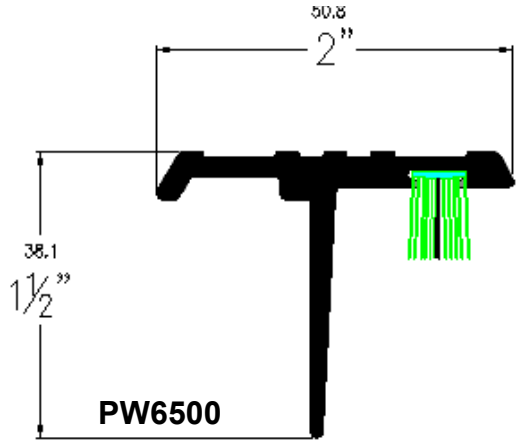

### SYNPRENE INSERT

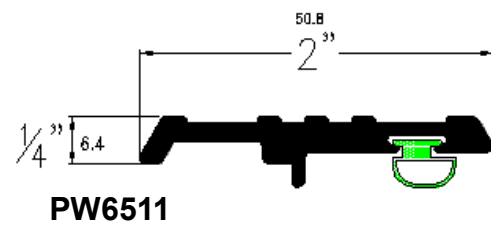
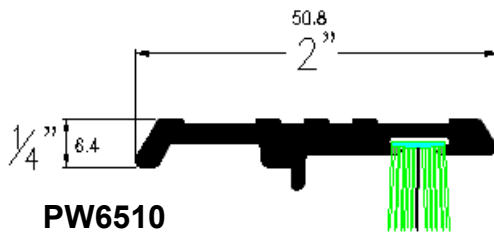
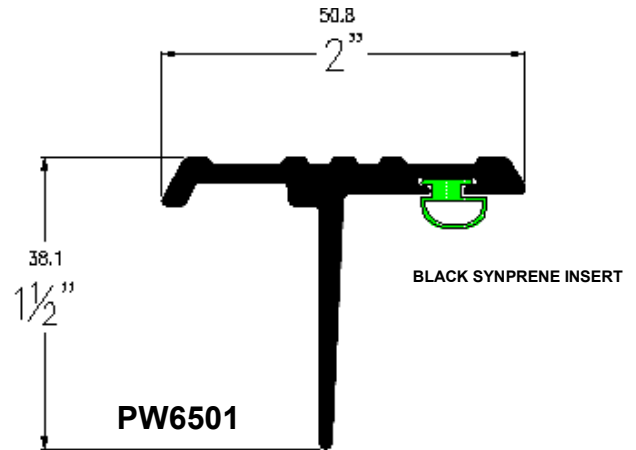

AVAILABLE LENGTHS  
84", 96"

AVAILABLE FINISHES  
C, Z

## MEETING STYLES

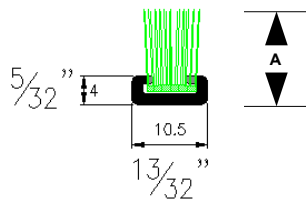

- |                                     |                                     |
|-------------------------------------|-------------------------------------|
| <b>PW6801</b> A=1/4" GREY FIN PILE  | <b>PW6805</b> A=1/2" GREY FIN PILE  |
| <b>PW6802</b> A=5/16" GREY FIN PILE | <b>PW6806</b> A=1/2" BLACK FIN PILE |
| <b>PW6803</b> A=3/8" GREY FIN PILE  | <b>PW6807</b> A=1/2" WHITE FIN PILE |
| <b>PW6804</b> A=7/16" GREY FIN PILE | <b>PW6808</b> A=9/16" GREY FIN PILE |

### PW6800

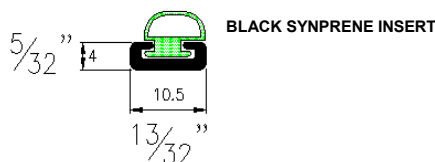

AVAILABLE LENGTHS  
SOLD BY THE FOOT

## FLAT OVERLAP BAR



AVAILABLE WIDTHS 2", 3", 4", 5"

AVAILABLE LENGTHS 84", 96" 144"

- PW6620** – 3/16" X 2" ALUMINUM or PRIMED STEEL
- PW6630** – 3/16" X 3" ALUMINUM or PRIMED STEEL
- PW6640** – 3/16" X 4" ALUMINUM or PRIMED STEEL
- PW6650** – 3/16" X 5" ALUMINUM or PRIMED STEEL

STAINLESS STEEL AVAILABLE AS SPECIAL ORDER  
(requires extra lead time)

## EXTERIOR (Special Order)

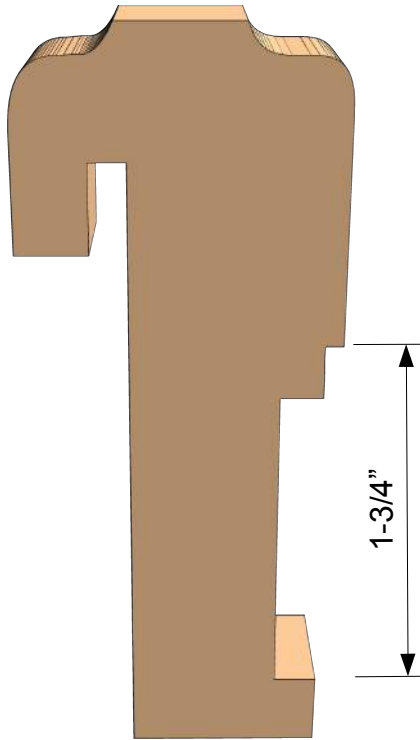

### WOOD

**PW6200 – CLEAR FIR 84"** (MACHINE FOR FLUSHBOLT AVAILABLE)

**PW6210 – PRIMED 84"** (MACHINE FOR FLUSHBOLT AVAILABLE)

**PW6220 – CLEAR FIR 96"** (MACHINE FOR FLUSHBOLT AVAILABLE)

**PW6230 – CLEAR FIR 120"** (MACHINE FOR FLUSHBOLT AVAILABLE)

### COMPOSITE

**PW6300 – SMOOTH WHITE 81", 97"**

**PW6310 – WOODGRAIN TEXTURE 81", 97"**

## INTERIOR (Special Order)

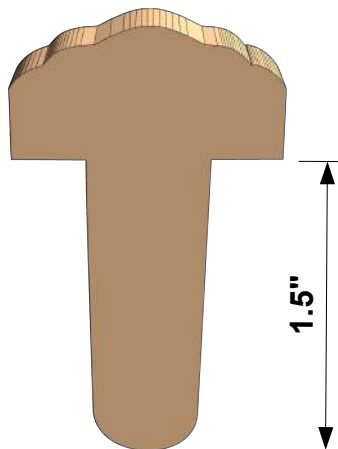

### WOOD

**PW6100 – CLEAR FIR 84"** (MACHINE FOR FLUSHBOLT AVAILABLE)

**PW6110 – PRIMED 80"** (MACHINE FOR FLUSHBOLT AVAILABLE)

**PW6120 – CLEAR FIR 80"** (MACHINE FOR FLUSHBOLT AVAILABLE)

## PLASTIC DOOR STRAP

**PW9050**



## PILE CORNER PAD

**PW5920**

